

Triangular Wave Generator Using Op-Amp

Sebin Sunny P

Assistant Professor, Department of Electrical & Electronics Engineering
Sreepathy Institute of Management And Technology

Vavanoor, Palakkad - 679533

sebinsunny@simat.ac.in

Theory:

Triangular waves are periodic, non-sinusoidal waveform with a triangular shape. A triangular wave is that it has equal rise and fall times while a sawtooth wave has unequal rise and fall times. To generate a triangular waveform, a square wave is passed through an integrator.

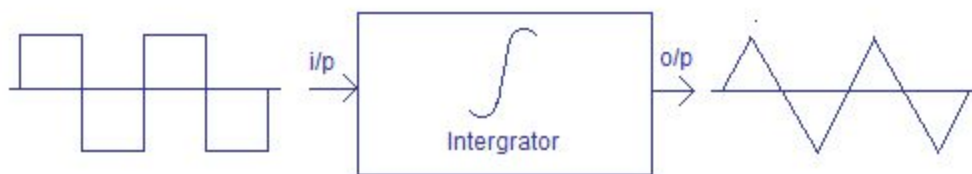

Figure: Generation of Triangular Waveform

Hence the main part of the circuit consist of:

1. A square wave generator
2. An integrator which converts the square wave to a triangular waveform.

Schematic Diagram:

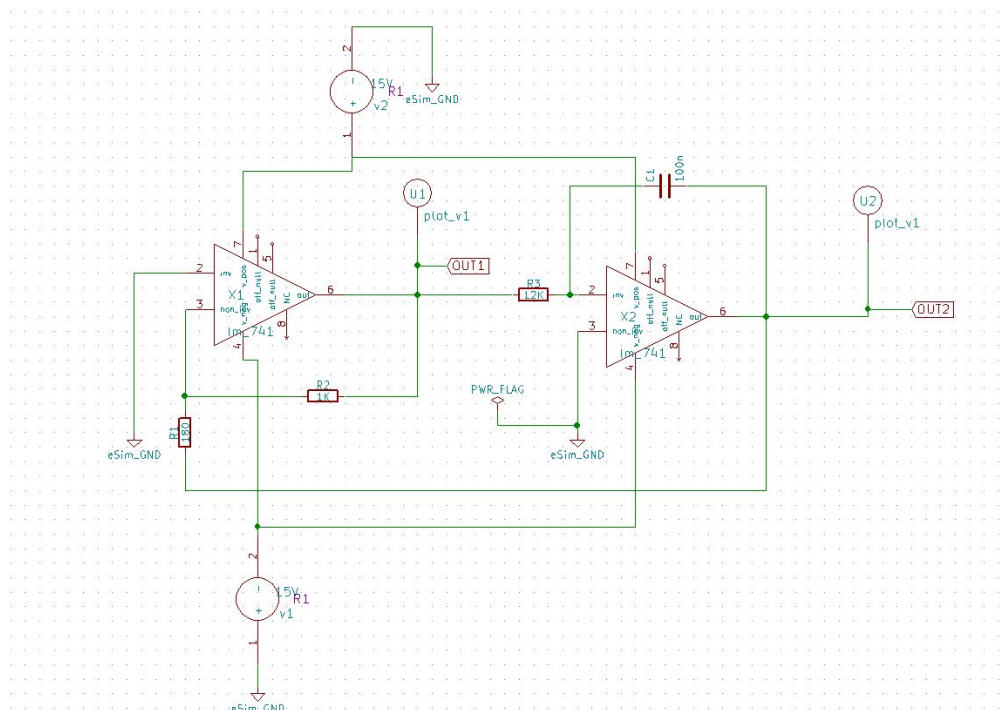

Figure 1: Circuit Diagram

Design:

First op-amp acts as a comparator and the second op-amp acts as an integrator.

$$f = R1/4R2R3C$$

Peak to peak amplitude of the ramp, $V_{opp} = 2 (R2/R1)V_{sat}$

Simulation Results :

Ngspice Plots

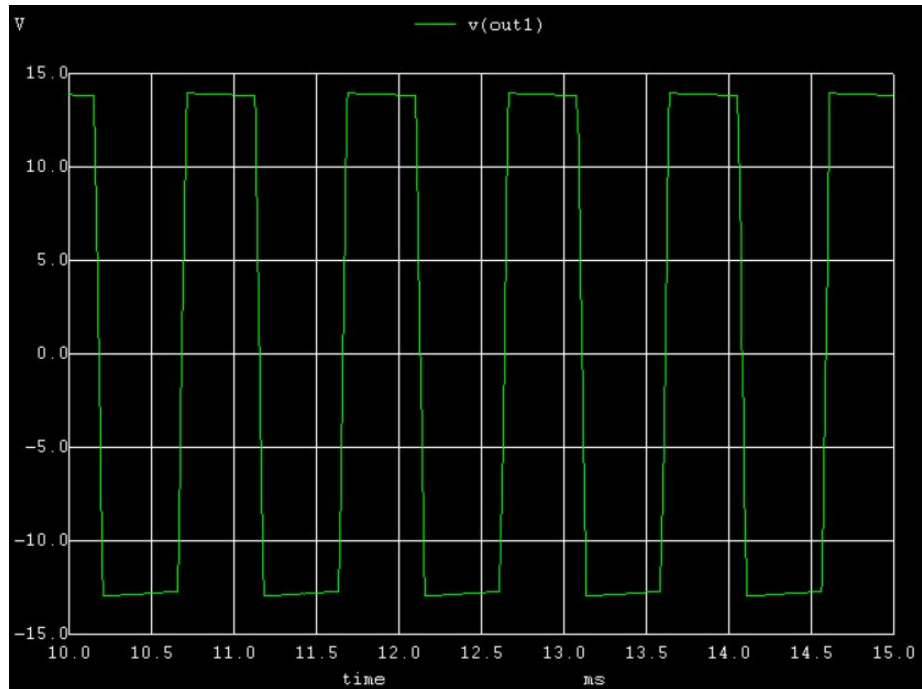

Figure 2: Square Wave Output

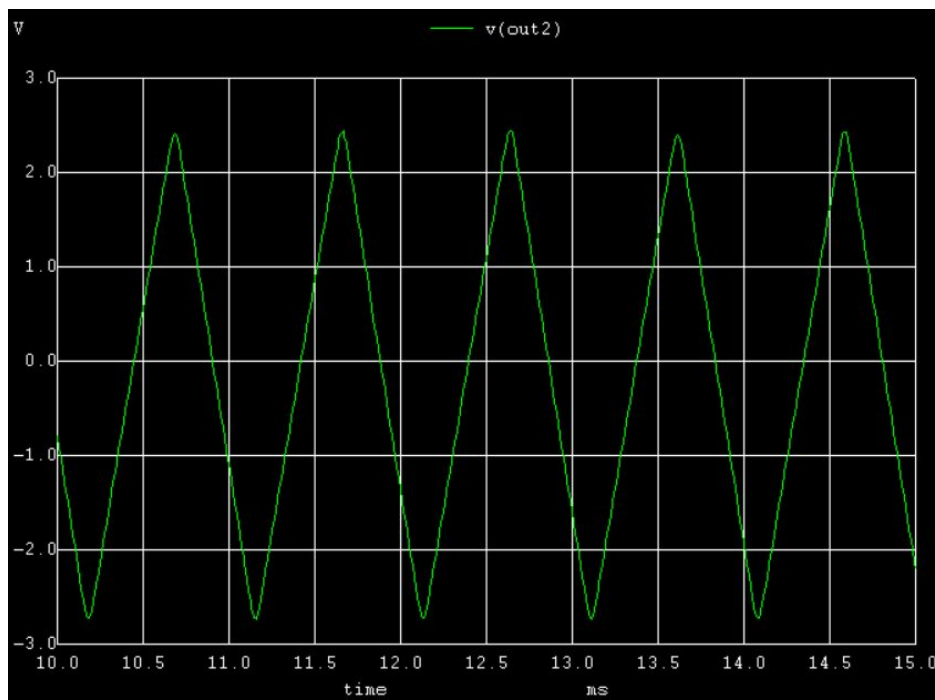

Figure 3: Triangular Wave Output

Python Plots:

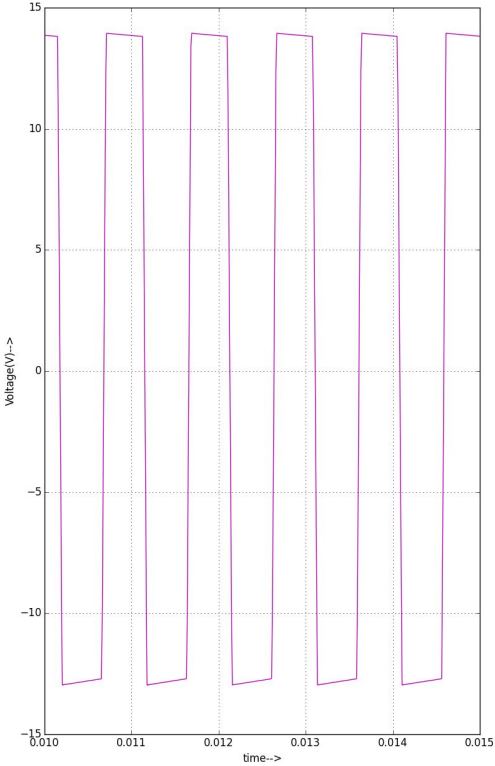

Figure 4: Square Wave Output

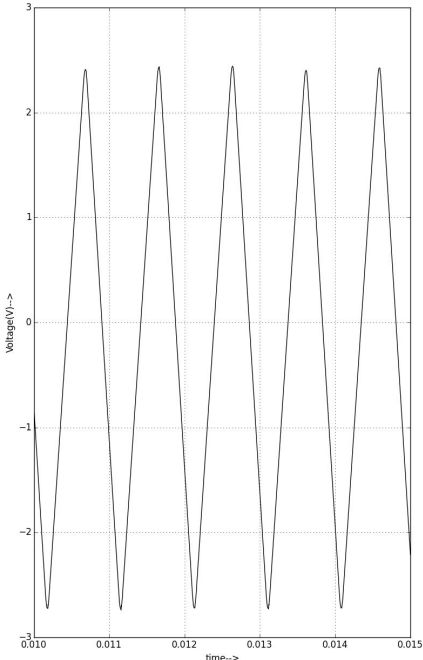

Figure 5: Triangular Wave Output

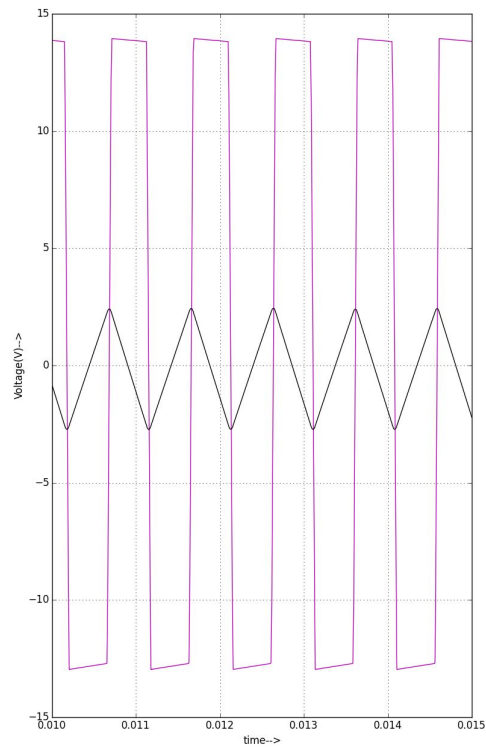

Figure 5: Square & Triangular Wave Output

Conclusion :

Designed and set up a triangular waveform generator using opamp and plotted the waveforms using esim.

Reference:

<http://www.circuitstoday.com/triangular-wave-generator>